



## DOUBLE SIDEBURNER 3282 Series

### INSTALLATION AND OPERATING INSTRUCTIONS



**INSTALLER:** Leave these instructions with consumer.  
**CONSUMER:** Retain for future reference.

**Important:** READ THESE INSTRUCTIONS CAREFULLY BEFORE STARTING INSTALLATION

### SAFETY WARNINGS & CODES

#### **⚠ DANGER**

##### **IF YOU SMELL GAS:**

1. Shut off the gas to the appliance.
2. Extinguish any open flame.
3. Open cover.
4. If odor continues, keep away from the appliance, and **immediately** call your gas supplier or fire department.

**CODE AND SUPPLY REQUIREMENTS:** This appliance must be installed in accordance with local codes and ordinances, or, in the absence of local codes, with either the latest *National Fuel Gas Code (ANSI Z223.1/NFPA 54)*, and *Natural Gas and Propane Storage and Handling Installation Code (CSA-B149.1)*.

This appliance and its individual shutoff valves must be disconnected from the gas supply piping system when testing the system at pressures in excess of ½ psig (3.5 kPa).

This appliance must be isolated from the gas supply piping system by closing its individual manual shutoff valves during any pressure testing of the gas supply system at pressures up to and including ½ psig (3.5 kPa).

#### **⚠ WARNING**

1. Do not store or use gasoline or other flammable vapors and liquids in the vicinity of this or any other appliance.
2. A propane cylinder not connected for use shall not be stored in the vicinity of this or any other appliance.

#### **WARNING**

Improper installation, adjustment, alteration, service, or maintenance can cause injury or property damage. Refer to this manual. For assistance or additional information consult a qualified professional installer, service agency, or the gas supplier.

All electrical outlets in the vicinity of the appliance must be properly grounded in accordance with local codes or, in the absence of local codes, with the ***National Electrical Code, ANSI/NFPA 70, or the Canadian Electrical Code, CSA C22.1***, whichever is applicable.

Keep all electrical supply cords and fuel supply hoses away from any heated surface.

**INSTALLATION INSTRUCTIONS ET MANUEL DU PROPRIÉTAIRE  
DANS LE CONTRE- DOUBLE SIDEBURNER****▲ DANGER:****SI VOUS SENTEZ LE GAZ :**

1. Coupez l'admission de gaz de l'appareil.
2. Éteindre toute flamme nue.
3. Ouvrir le couvercle.
4. Si l'odeur persiste, éloignez-vous de l'appareil et appelez immédiatement le fournisseur de gaz ou le service d'incendie.

**▲ AVERTISSEMENT:**

1. Ne stockez pas ou n'employez pas l'essence ou d'autres vapeurs et liquides inflammables à proximité de ceci ou d'aucun autre appareil.
2. Un cylindre de propane non relié pour l'usage ne sera pas stocké à proximité de ceci ou d'aucun autre appareil.

**CONDITIONS DE CODE ET D'APPROVISIONNEMENT:**

Ce gril doit être installé selon des codes et des ordonnances locaux, ou, en l'absence des codes locaux, avec l'un ou l'autre le plus défunt *Code national de gaz de carburant* (norme ANSI Z223.1/NFPA 54), et *Stockage de gaz naturel et de propane et manipulation du code d'installation* (CSA-B149.1).

Cet appareil et ses différents robinets d'isolement doivent être démontés du gaz-fournissent le système sifflant en examinant le système aux pressions au-dessus du ½ psig (kPa 3.5).

Cet appareil doit être isolé dans gaz-fournissent le système sifflant par fermeture que ses différents robinets d'isolement manuels pendant tous les essais sous pression du gaz-fournissent le système aux pressions jusques et y compris le ½ psig (kPa 3.5).

- Ce gril est pour utilisation à l'extérieur seulement. Si l'appareil est entreposé à l'intérieur, enlever les bouteilles et les laisser à l'extérieur.
- Ne pas ranger le gril immédiatement après l'avoir utilisé. le laisser refroidir avant de le déplacer ou de la ranger. Le non respect de cette mesure de sécurité pourrait entraîner un incendie causant des dommages à la propriété, des blessures ou la mort.
- Ne pas utiliser cet appareil sous une surface combustible.
- Ne pas utiliser cet appareil sous un auvent. Le non respect de cette mesure de sécurité pourrait entraîner un incendie ou des blessures.
- Dégagement minimal entre les parois latérales et l'arrière de l'appareil et la construction combustible (45.7 cm à partir des parois latérales et 45.7cm à partir de l'arrière).
- Le régulateur de pression de gaz prévu avec cet appareil de cuisson à gaz pour l'extérieur doit être utilisé. Ce régulateur est réglé pour une pression de sortie de 5 pouces de colonne de l'eau pour le gaz naturel, et 10 pouces pour le propane.
- LE RÉGULATEUR INCLUS D'APPAREILS EST ÉVALUÉ POUR LE MAXIMUM DE 1/2 (LIVRES PAR POUCE CARRÉ). SI VOTRE OFFRE DE GAZ EST 1/2 PLUS GRAND QUE (LIVRES PAR POUCE CARRÉ), UN RÉGULATEUR ADDITIONNEL DOIT ÊTRE INSTALLÉ AVANT LE GRIL. VOIR LA SECTION DE CONDITIONS D'OFFRE DE GAZ POUR

**▲ AVERTISSEMENT:**

L'installation inexacte, l'ajustement, le changement, le service, ou l'entretien peuvent causer des dommages ou des dégâts matériels. Référez-vous à ce manuel. Pour l'aide ou l'information additionnelle, consultez un installateur professionnel qualifié, l'agence de service, ou le fournisseur de gaz.

Toutes les sorties électriques à proximité du gril doivent être correctement fondues selon des codes locaux, ou en l'absence de local code, avec le code électrique national, ANSI/NFPA 70, ou le code électrique canadien, CSA C22.1, celui qui est applicable.

Maintenez tout électrique-fournissent des cordes et carburant-fournissent des tuyaux partis de n'importe quelle surface de chauffage.

**LA PRESSION APPROPRIÉE D'OFFRE DE GAZ.**

- Ne couvrez jamais la surface entière de cuisine ou de gril de gauffreuses ou de casseroles. La surchauffe se produira et les brûleurs ne seront pas très performants quand la chaleur de combustion est emprisonnée au-dessous de la surface à cuire.
- Ne pulvérisez jamais l'eau sur une unité chaude de gaz, comme ceci peut endommager des composants de porcelaine ou de fer de fonte.
- Une fuite de GPL peut causer un incendie ou une explosion si enflammée entraînant des blessures corporelles graves ou la mort.
- Communiquez avec le fournisseur de GPL pour les réparations ou pour disposer de qules bouteille ou du GPL non utilisé.

**INSTALLATEUR : Laissez ces instructions avec le consommateur.  
CONSOMMATEUR : Maintenez pour la future référence.**

# DOUBLE SIDEBURNER PARTS LIST

**Item Description**

- 1. STAINLESS STEEL COVER
- 2A. GRID, STAINLESS STEEL
- 2B. GRID, PORCELAIN CAST IRON
- 3. BURNER ASSEMBLY
- 4. VALVE MANIFOLD ASSEMBLY
- 5. KNOBS (2)
- 6. CONTROL PANEL, STAINLESS STEEL
- 7. REGULATOR
- 8. IGNITOR ASSY

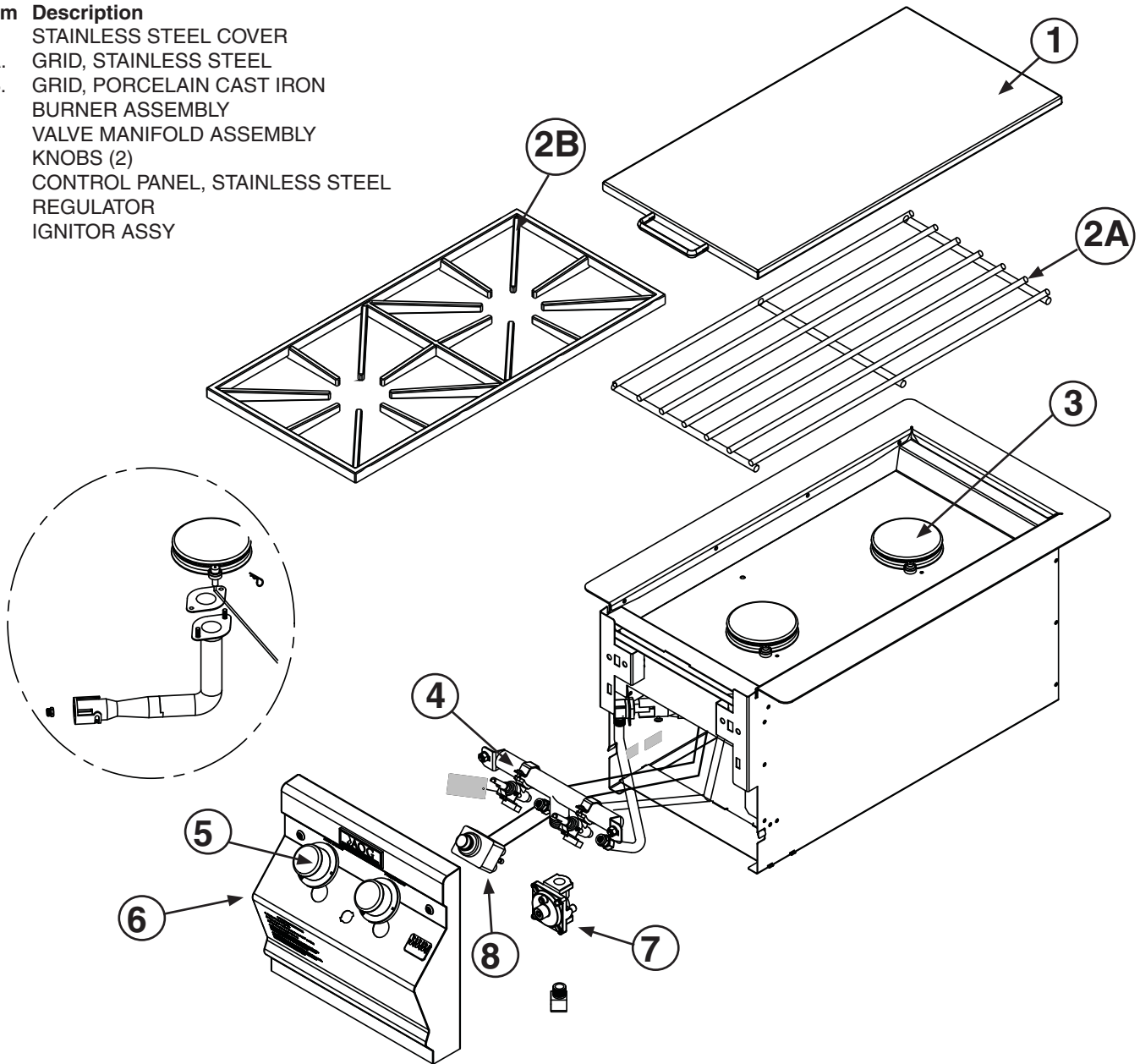

## PRODUCT DATA TABLE

Specification	Value
Counter Opening Height*	12"
Counter Opening Width*	11 1/2"
Counter Opening Depth*	22 3/4"
<b>Double Side Burner</b>	
BTU per burner	15,000
Natural Gas Orifice	#51
Propane Gas Orifice	#58

Table 1 - Product data table

## PREPARING FOR INSTALLATION

### WHERE TO INSTALL YOUR DOUBLE SIDEBURNER FOR OUTDOOR USE ONLY.

Your double sideburner is designed to complement your grill. It provides a convenient, efficient cooking surface for side dishes that require bottom heat only.

#### TOOLS REQUIRED

The double sideburner has been pre-assembled. You need only a pair of wrenches, pliers, or vice grips for the gas connection.

#### CODE AND SUPPLY REQUIREMENTS

This burner must be installed in accordance with local codes and ordinances, or, in the absence of local codes, with the National Fuel Gas Code, ANSI Z223.1.

This appliance and its individual shutoff valve must be disconnected from the gas supply piping system when testing the system at pressures in excess of  $1/2$  psig (3.5 kpa).

The appliance must be isolated from the gas supply piping system by closing its individual manual shutoff valve during any pressure testing of the gas supply system at pressures up to and including  $1/2$  psig (3.5 kpa).

#### ELECTRICAL OUTLETS

Electrical outlets in the vicinity of this appliance must be properly grounded and GFI equipped.

**Important:** This unit may be installed into combustible framing (wood, for instance) provided there is a minimum of a  $1/2$ " airspace between the sides of the unit and any combustible material. This hanger requires  $1 1/2$ " of countertop on each side and back to support the unit.

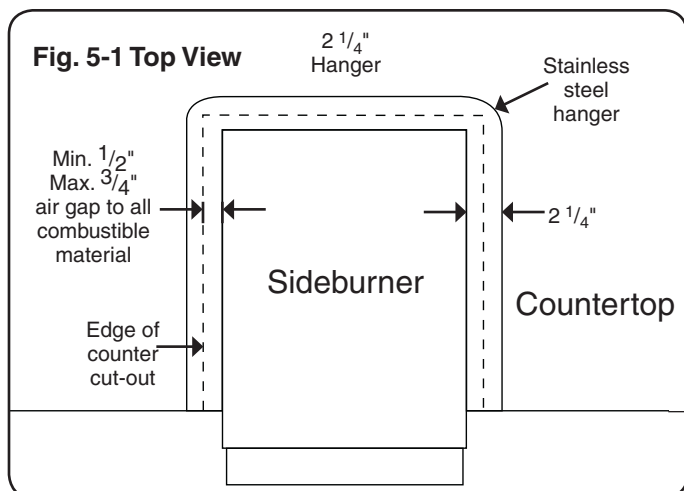

Do not install this unit under unprotected flammable surfaces. Do not install or use this appliance inside a building, garage, or any other covered area. It must not be used in or on recreational vehicles or boats.

This is a built-in type unit designed to fit into open-front enclosures. The control panel of the unit is removable for gas hookup, servicing, and burner adjustment. The control panel must be removable after you install the unit.

**INSTALLER NOTE:** This unit should be installed so that it can be removed at a later date if factory service is required. Any protrusion into the double sideburner enclosure may prevent the unit from sliding into place (see GAS SUPPLY PLUMBING REQUIREMENTS, on page 5).

#### ENSURING PROPER COMBUSTION AIR AND COOLING AIR FLOW

You must maintain proper air flow for your double sideburner to perform as it was designed. If airflow is blocked, overheating and poor combustion will result. Make sure not to block the 1" front air inlet along the bottom of the control panel or more than 75% of the support grid surface with pans or griddles.

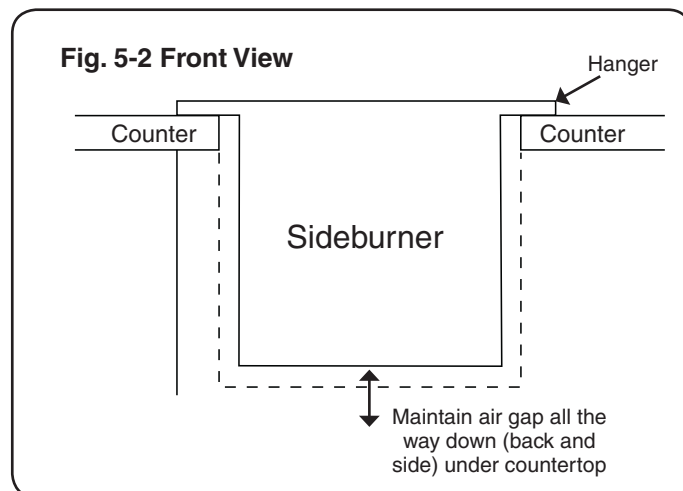

## PREPARING FOR INSTALLATION (Cont.)

### GAS SUPPLY PLUMBING REQUIREMENTS:

The gas supply pipe connection is to be made through the floor at the rear of the enclosure. Install the gas line stub at least 2" away from the side walls and 1" from the back wall, but within 5" of the back wall, as illustrated by the shaded area X in Fig. 6-1.

**CAUTION:** An external valve (with a removable key) in the gas line is advised for safety and convenience, particularly if the unit is accessible to children.

### GAS SUPPLY AND MANIFOLD PRESSURES:

For **natural gas** - normal 7" water column (w.c.), minimum 3-1/2", maximum 10-1/2". For **propane gas** - normal 11" w.c., minimum 8", maximum 13".

**A REGULATOR MUST BE PROVIDED AT THE BOTTLE OR GAS SOURCE FOR USE WITH PROPANE GAS.**

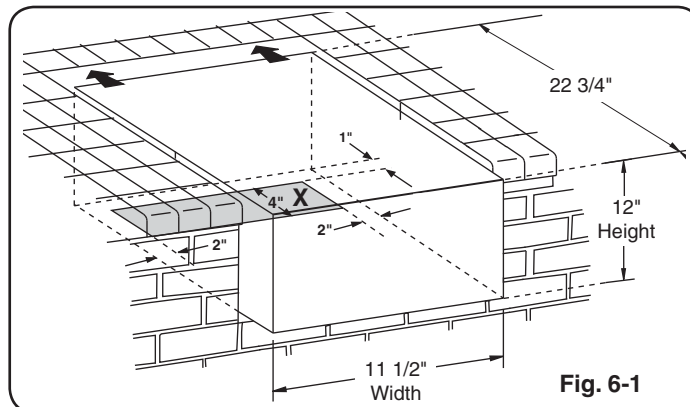

## INSTALLATION

### 1. CHECKING FUEL AND PROPER ORIFICES

AOG units are equipped with orifices for natural gas, unless otherwise indicated. For use with propane gas, smaller orifices must be installed to avoid hazardous overheating. Please refer to Table 1 for the correct orifice size. Check the orifice size by following the instructions below. The drill size is stamped on the orifice. If the number is not visible you may have to remove the orifice (as detailed below) to read the number stamped on the side of the orifice.

**IF YOU ARE NOT SURE YOU HAVE THE CORRECT SIDEBURNER ORIFICE SIZE (OR WISH TO CHANGE THE ORIFICE), FOLLOW THE STEPS BELOW.**

**CAUTION:** If the burner has been in use, wait until the burner and its components are cool to the touch.

- Remove sideburner cover and lift off cooking grid.
- Remove the control knobs and screws first, then carefully lift away the control panel.

**Note:** Carefully, lift the control panel away from the frame. The spark generator for the ignition system is attached to the inside of the control panel. The spark generator knob need not be detached, but the wires must be unplugged from the generator before the face is completely removed.

- Reach up under the burner support and remove the burner retaining clip (see Fig. 6-1), located at the rear of the burner pipe.
- Remove the burner cap and carefully lift the burner up and out, clearing the ceramic electrode (see Fig. 6-2), and pulling the burner tube away from the orifice, located on the end of the orifice holder on the left side of the unit (see Fig. 6-3).

**Note:** You do not have to lift the burner completely out of the unit to access the orifice.

- Using a 3/8" socket, remove orifice from the orifice holder (see Fig. 6-3) and check the number stamped on the orifice face.

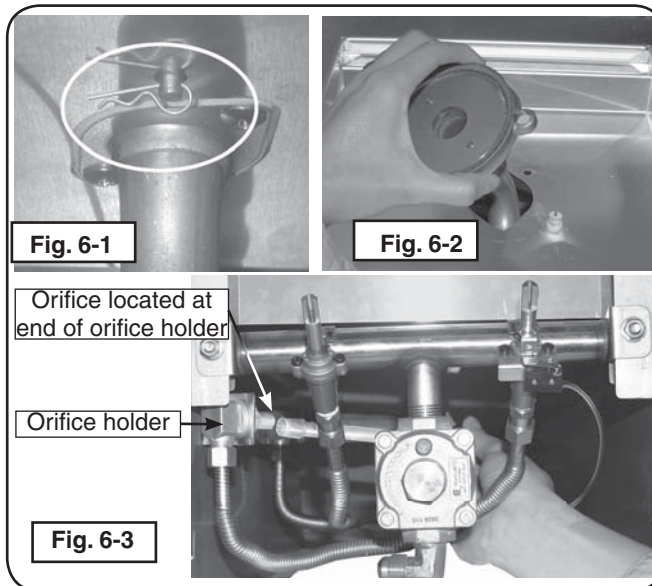

## INSTALLATION (Cont.)

- f. If an orifice change is necessary, replace the orifice with the correct sized one.
- g. Replace the sideburner tube over the orifice, aligning the burner over the electrode, taking care not to detach it from the wire.
- h. Replace the burner retaining clip (underneath burner), and burner cap.
- i. Repeat steps c. through h. for the second burner, then replace the grid and cover.

**Important:** If converting the gas type, see the CHECKING AND CONVERTING THE REGULATOR section before replacing the control panel.

- j. Replace the control panel, being sure to reconnect the spark generator wires. Replace the control knobs.

### 2. CONNECTING THE GAS SUPPLY

- a. The burner manifold has a 1/2" male flare fitting gas inlet elbow. A 1/2" female flare fitting connector nut is required to hook the gas supply to the burner.
- b. Use a stainless steel flex connector to bring the gas supply from the gas line stub or propane gas tank to the single sideburner manifold. A 1/2" x 24" or 36" flex connector is suitable for most installations.

**CAUTION:** Use only a C.S.A. listed stainless steel flex connector. Do not use a rubber hose or plastic hose within the enclosure for your single sideburner; it will leak, resulting in an explosion and/or serious injury.

- c. Be sure the gas supply is **OFF**. Connect the pipe adapter fitting supplied with the flex connector to the gas supply stub. Use pipe joint compound that is resistant to all gasses on the pipe fitting. Tighten fitting to the gas supply and connector flare nut securely.

**Note:** Pipe joint compound should not be used on flare fitting connections.

- d. Connect the flex connector flare nut to the single sideburner manifold elbow flare fitting. Be sure to tighten securely. Use a second wrench to support the manifold to avoid damaging the manifold.

- e. Check all gas connections for leaks with a brush and soapy water solution before lighting. **NEVER USE A MATCH OR OPEN FLAME TO TEST FOR LEAKS.**

- f. Slide the unit into the enclosure.

**Note:** Each side of the unit has a tab just behind the control panel. These tabs prevent the control panel from moving inward. If the tabs interfere with the unit sliding in (see Fig. 7-1), use pliers to bend them inward so that they clear the enclosure sides. Leave the tabs slightly out to ensure they still keep the control panel from moving inward (see Fig. 7-2).

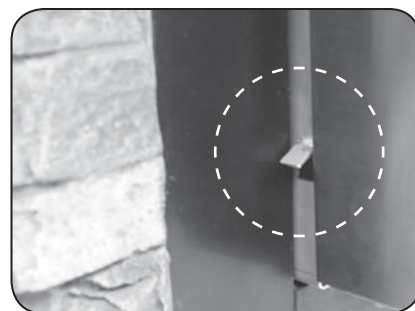

Fig. 7-1 Tab may interfere when sliding in unit

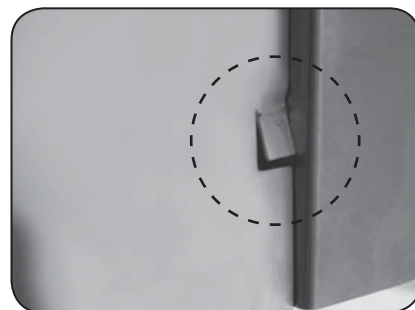

Fig. 7-2 Tab slightly bent in for clearance

### 3. POSITIONING THE BURNER CAP

Place the burner cap so it is centered over the burner. Ensure that it rests securely in place.

## AIR SHUTTER ADJUSTMENT

Air shutters are preset at the factory based on the gas the sideburner is built to burn. However, altitude or other local conditions may require air shutter adjustment for proper combustion.

The flames from a properly adjusted sideburner will touch the burner ports and appear mostly blue.

If they are orange, “lazy,” or lift off the burner ports, then adjust the sideburner air shutter using the following steps.

The air shutters are located at the end of the burner assemblies, behind the control panel. They can safely and easily be adjusted while the unit is lit.

**CAUTION:** Do not touch the sideburner surrounding top area, as it will be hot while adjusting the air shutter.

1. Remove the control knobs and screws first, then carefully lift away the control panel.

**Important:** Prior to fully removing the control panel, you must disconnect the battery holder assembly wires that are located behind the control panel.

2. Replace the control knobs back on to the valve stems.
3. Light the sideburner following the LIGHTING INSTRUCTIONS section.

4. Loosen the front burner air shutter adjustment screw, then use the tip of a screwdriver to open or close the air shutter until the flames appear blue and touch the burner ports.

5. Retighten the adjustment screw.

6. Repeat for rear burner air shutter.

**Should you have difficulty accessing the rear burner air shutter, you may shut down, remove the rear burner (when cool), then adjust the air shutter to the same opening as the already adjusted front burner. (See INSTALLATION section to remove rear burner.) Be sure to properly reinstall rear burner when complete.**

7. Once all adjustments are complete; be sure the unit is off and remove the knobs, then replace the control panel, being sure to reconnect the battery holder assembly wires. Replace the control knobs.

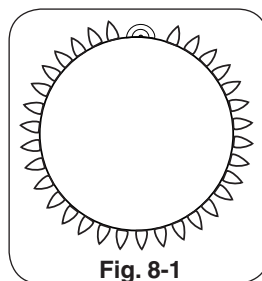

Fig. 8-1

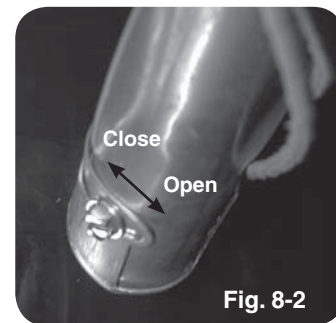

Fig. 8-2

## SAFETY TIPS

Each time you use your double sideburner, ensure that:

1. The area around the unit is clear and free from gasoline and other flammable vapors, liquids, and materials.
2. There is no blockage of air flow around the burner.
3. When using propane gas:
  - a. The special ventilation openings in the enclosure are kept free and clear of debris.
  - b. If connected to a propane cylinder, the rubber hose attached to the regulator is carefully inspected before each use.
  - c. The propane cylinder, regulator, and rubber hose are installed in a location not subject to heating above 125° F (51° C).
4. Burner flames are burning evenly around the burner cap with a steady flame (mostly blue). A proper flame pattern will ensure safe operation and optimal performance. See AIR SHUTTER ADJUSTMENT section.

**Do not operate the burner with the cover in place.**

The valve, igniter, and burner on your double sideburner have been **pre-assembled** and **tested before shipping**. We suggest you follow and practice these instructions for safe lighting of your double sideburner.

## SIDEBURNER NOTES PAGE

Please use this page to record any information about your sideburner that you may want to have at hand.

# LIGHTING (IGNITION) INSTRUCTIONS

Read all instructions before lighting, and follow these instructions each time you light the unit.

## ELECTRONIC LIGHTING

**Note:** Electronic lighting requires an installed AA battery with a good charge.

1. Open lid(s) or remove cover(s) from burner(s) to be lit.
2. Turn all gas control knob(s) to their **OFF** position(s).
3. Turn on the gas at its source.

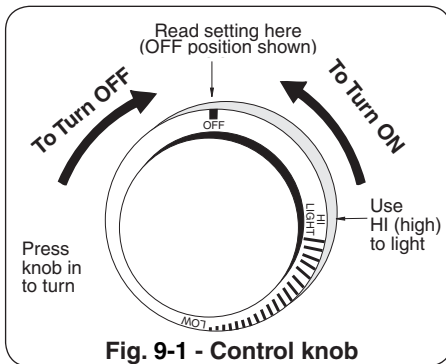

Fig. 9-1 - Control knob

**Note:** DO NOT turn on more than one valve at a time for either electronic or manual lighting.

4. Press the ignitor button, the ignitor will produce a clicking sound. Immediately press in the control knob, and turn to the **HI LIGHT** position. Keep holding the ignitor button until the burner lights, then release it.

**CAUTION:** If a burner does not light within five (5) seconds of turning on the control knob, depress the knob and turn it to the **OFF** position. **WAIT FIVE (5) MINUTES** before repeating step 4. If you smell gas, follow the instructions on the cover of this manual. If the burners still do not light after several attempts, refer to the instructions for manual lighting.

5. Repeat step 4 for each additional burner to be lit.

## WHEN USING A PORTABLE PROPANE TANK

Propane tanks are equipped with a safety shutdown device that may cause low or no gas pressure/flame at the burners if operating and lighting instructions are not followed exactly (See important note in the TROUBLESHOOTING section for more details.)

## MANUAL LIGHTING

**CAUTION:** Always wait five (5) minutes for gas to clear after any unsuccessful lighting attempt.

1. Follow steps 1 through 3 (left).
2. Insert either a burning long-barrel butane lighter, a burning long-stem match, or a burning match held by a wire extension holder through the cooking grid opening to the burner (Fig. 9-2). Hold the flame against the edge of the burner.
3. While holding the match or lighter flame next to the burner, depress the control knob and while pressing turn it counterclockwise to the **HI LIGHT** position. Remove the lighter or match when the burner lights, and release the control knob.
4. If the burner does not light, **immediately depress the knob and turn the valve to OFF. WAIT FIVE (5) MINUTES** before repeating steps 2 through 4 of the **MANUAL LIGHTING** instructions.

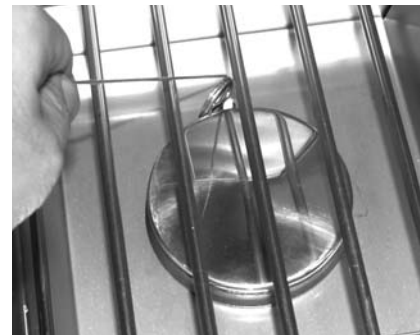

Fig. 9-2 - Manual lighting

## SHUTTING OFF THE UNIT

To shut off the unit, depress each valve control knob and, while pressing turn it clockwise to the **OFF** position.

Always close the valve from the gas supply after each use of the unit.

# ALLUMAGE DES INSTRUCTIONS (D'ALLUMAGE)

Lisez toutes les instructions avant l'allumage, et suivez ces instructions chaque fois vous lumière le unité.

## ÉCLAIRAGE ÉLECTRONIQUE

**Note:** L'éclairage électronique exige une batterie installée d'AA avec une bonne charge.

1. Ouvrez les couvercles ou enlevez les couvertures des brûleurs pour être Lit.
2. Tournez tous les boutons de commande de gaz à leurs positions de repos.
3. Allumez le gaz à sa source.

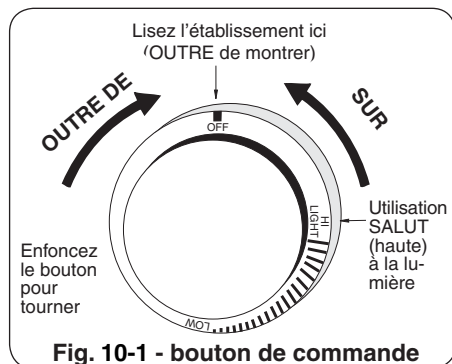

**Note:** N'ouvrez pas plus d'une valve à la fois pour l'éclairage électronique ou manuel.

4. Appuyez sur le bouton d'allumeur, l'allumeur produira un bruit cliquant sur. Enfoncez immédiatement le bouton de commande, et tournez-vous vers la position LÉGÈRE de HI. Continuez à tenir le bouton d'allumeur jusqu'à ce que le brûleur s'allume, puis libérez-le.

**ATTENTION :** Si un brûleur ne s'allume pas dans cinq (5) secondes d'allumer le bouton de commande, enfoncez le bouton et tournez-le à la position de repos. ATTENDEZ CINQ (5) MINUTES avant de répéter l'étape 4. Si vous sentez le gaz, suivez les instructions sur la couverture de ce manuel. Si les brûleurs ne s'allument toujours pas après que plusieurs tentatives, se rapportent aux instructions pour l'éclairage manuel.

5. Répétez l'étape 4 pour que chaque brûleur additionnel soit Lit.

## ÉCLAIRAGE MANUEL

**ATTENTION:** Attendez toujours cinq (5) minutes le gaz pour se dégager après que n'importe quelle tentative non réussie d'éclairage.

1. Suivez les étapes 1 à 3 (à gauche).
2. Insérez un allumeur brûlant de butane de long-baril, une allumette brûlante de long-tige, ou une allumette brûlante tenue par un support de prolongation de fil par la grille à cuire s'ouvrant au brûleur (fig. 10-2). Tenez la flamme contre le bord du brûleur.
3. Tout en tenant l'allumette ou la flamme plus légère à côté du brûleur, diminuez le bouton de commande et tout en pressant le tour il dans le sens contraire des aiguilles d'une montre dans la position LÉGÈRE de HI. Enlevez l'allumeur ou assortissez quand le brûleur s'allume, et libérez le bouton de commande.
4. Si le brûleur ne s'allume pas, enfoncez immédiatement le bouton et tournez la valve à AU LOIN. ATTENDEZ CINQ (5) MINUTES avant de répéter les étapes 2 à 4 des instructions manuelles d'éclairage.



Fig. 10-2 - Éclairage manuel

## ARRÊT DU UNITÉ

Pour couper le unité, diminuez chaque bouton de commande de valve et, et tout en pressant tour il dans le sens des aiguilles d'une montre à la position de repos.

Fermez toujours la valve de la fourniture de gaz après chaque utilisation du unité.

## EN EMPLOYANT UN RÉSERVOIR DE PROPANE PORTATIF

Des réservoirs de propane sont équipés d'un dispositif d'arrêt de sûreté qui peut ne pas causer le bas ou aucunes pression de gaz/flamme aux brûleurs si le fonctionnement et l'allumage des instructions ne sont pas suivis exactement (voir la note importante dans la section de dépannage pour plus de détails.)

# SAFE USE & MAINTENANCE OF PROPANE GAS CYLINDERS

## IMPORTANT FOR YOUR SAFETY

### READ AND FOLLOW ALL WARNINGS PROVIDED WITH THE PROPANE-GAS CYLINDER.

When operating this appliance with a propane-gas cylinder, these instructions and warnings **MUST** be observed.

**FAILURE TO DO SO MAY RESULT IN A SERIOUS FIRE OR EXPLOSION.**

## CYLINDER/CONNECTOR REQUIREMENTS

- a. Propane-gas cylinders, valves, and hoses must be maintained in good condition and must be replaced if there is visible damage to either the cylinder or valve. If the hose is cut or shows excessive abrasion or wear, it must be replaced before using the gas appliance (see e.).
- b. This unit, when used with a cylinder, should be connected to a standard 5-gallon (20 lb.) propane-gas cylinder equipped with an OPD (Overfill Prevention Device). The OPD has been required on all cylinders sold since October 1, 1998, to prevent overfilling.
- c. Cylinder dimensions should be approximately 12" (30.5 cm) in diameter and 18" (45.7 cm) high. Cylinders must be constructed and marked in accordance with the *Specifications for Propane Gas Cylinders of the U.S. Department of Transportation (D.O.T.)* or the National Standard of Canada, *CAN/CSA-B339, Cylinders, Spheres, and Tubes for Transportation of Dangerous Goods*.
- d. The cylinder used must include a collar to protect the cylinder valve, and the cylinder supply system must be arranged for vapor withdrawal.
- e. The pressure regulator and hose assembly used must match the specification for Type I by *ANSI Z 21.58-2005/CGA 1.6-2005* (see Fig. 11-1).
- f. The propane-gas cylinder valve must be equipped with a cylinder connection coupling device, described as Type I in the standard defined in paragraph e. above. This device is commonly described as an Acme thread quick coupler.
- g. If the propane-gas cylinder comes with a dust plug, place the dust cap on the cylinder valve outlet whenever the cylinder is not in use.

## QUICK COUPLER OPERATION

**To connect the regulator/hose assembly to the propane-gas cylinder valve fitting:** Press the hand nut on the regulator over the Acme thread fitting on the cylinder valve. Turn the hand nut clockwise to engage the threads and tighten until snug.

## ENCLOSURE REQUIREMENTS

**FOR YOUR SAFETY, you must provide the openings listed below for drainage, replacement air, and cross-ventilation of any storage area exposed to possible leakage from gas connections, the unit, or propane cylinders:**

One side of the gas cylinder enclosure left completely open to the outside **OR** by providing four (4) ventilation openings. Two (2) openings are to be at the cylinder valve level (approx. 16" [40.6 cm] above the floor) and on opposite walls of the enclosure. Two (2) more openings must be at the floor level on opposite sides of the enclosure. The floor-level openings must start at the floor and shall extend no higher than 5" (12.7 cm) above the floor. Each opening must have a minimum of 10 sq. in. (64.5 cm<sup>2</sup>) of free area. To achieve the proper ventilation, you may drill a series of holes, omit the grout from masonry joints, or replace a brick with a hardware cloth screen. If the floor in the cabinet is raised and the space beneath the cabinet is open to the outside, the lower ventilation openings may be in the floor.

Consult your gas supplier for ventilation and regulator requirements when connecting to a household propane supply.

The use of pliers or a wrench should not be necessary. Only cylinders marked "propane" may be used.

**To disconnect:** Turn the hand nut counterclockwise until detached (Fig. 11-1).

**Important:** Before using the unit, and after each time the cylinder is removed and reattached, check the hose for wear (see a.) and check all connections for leaks. Turn off the unit valves and open the main cylinder valve, then check connections with soapy water. Repair any leaks before lighting the unit.

**CAUTION:** Always turn the propane cylinder main valve off after each use, and before moving the unit and cylinder or disconnecting the coupling. This valve must remain closed and the cylinder disconnected while the appliance is not in use, even though the gas flow is stopped by a safety feature when the coupler is disconnected.

**Carefully** inspect the hose assembly each time before the gas is turned on. A cracked or frayed hose should be replaced immediately.

If the appliance is stored indoors, the cylinder must be disconnected and removed. Disconnected cylinders must be stored outdoors, out of the reach of children, with threaded valve plugs tightly installed, and must not be stored in a building, garage, or any other enclosed area.

## FOR YOUR SAFETY

- a. DO NOT store a spare propane-gas cylinder under or near this appliance.
- b. NEVER fill the cylinder beyond 80-percent full.
- c. IF THE INFORMATION IN a. AND b. IS NOT FOLLOWED EXACTLY, A FIRE CAUSING DEATH OR SERIOUS INJURY MAY OCCUR.

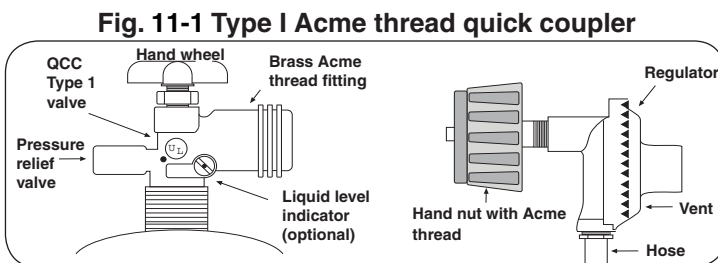

# UTILISATION SÛRE ET ENTRETIEN DES CYLINDRES DE GAZ DE PROPANE

## IMPORTANT POUR VOTRE SÛRETÉ

LISEZ ET SUIVEZ TOUS LES AVERTISSEMENTS ÉQUIPÉS DE VOTRE CYLINDRE DE GAZ DE PROPANE.

En actionnant cet appareil avec un cylindre de gaz de propane ON DOIT observer ces instructions et avertissements.

**LE MANQUE DE FAIRE AINSI PEUT AVOIR COMME CONSÉQUENCE UNE INCENDIE OU UNE EXPLOSION SÉRIEUSE.**

### CYLINDRE ET CONDITIONS ET CARACTÉRISTIQUES DE CONNECTEUR

- Des cylindres et les valves de gaz de propane doivent être maintenus en bon état et doivent être remplacés s'il y a des dommages évidents au cylindre ou à la valve.
- Ce gril, une fois utilisé avec un cylindre, devrait être relié à un gallon de la norme 5 (20lb.) cylindre de gaz de propane équipé d'un OPD (remplissez au-dessus du niveau le dispositif d'empêchement). L'OPD a été exigé sur tous les cylindres vendus depuis octobre 1.1998 pour empêcher le remplissage excessif.
- Les dimensions de cylindre devraient être approximativement 12" (30.5cm) de diamètre et 18" (45.7cm) hauts. Des cylindres doivent être construits et marqués selon les caractéristiques pour des cylindres de gaz de propane du département des ETATS-UNIS du transport (D.O.T.) ou le niveau national du Canada, du CAN/CSA-B339, des cylindres, des sphères et des tubes pour le transport des marchandises dangereuses.
- Le cylindre doit inclure un collier pour protéger la valve de cylindre et le circuit d'alimentation de cylindre doit être assuré le retrait de vapeur.
- Le régulateur de pression et l'ensemble de tuyau utilisé doivent assortir les spécifications pour le type I par ANSI Z 21.58-2005/CGA 1.6-2005 (voir la fig. 12-1).
- La valve de cylindre de gaz de propane doit être équipée d'un dispositif d'accouplement de raccordement de cylindre, décrit comme type I dans la norme définie dans le e. de paragraphe ci-dessus. Ce dispositif est généralement décrit comme coupleur rapide de fil de point culminant.
- Si votre cylindre de gaz de propane vient avec une prise de la poussière, placez le bouchon anti-poussière sur la sortie de valve de cylindre toutes les fois que le cylindre n'est pas en service.

### OPÉRATION DE COUPLEUR RAPIDE

**Pour relier le régulateur/hose à l'ajustage de précision de valve de cylindre de gaz de propane:** Serrez l'écrou de main sur le régulateur au-dessus de l'ajustage de précision de fil de point culminant sur la valve de cylindre. Tournez l'écrou de

main dans le sens des aiguilles d'une montre pour engager les fils et pour serrer jusqu'à ce que douillettement. L'utilisation des pinces ou de la clé ne devrait pas être nécessaire. Seulement le propane marqué par cylindres doit être employé.

**Pour débrancher:** Tournez l'écrou de main dans le sens contraire des aiguilles d'une montre jusqu'à isolé (fig. 12-1).

**Important:** Avant d'employer le gril, et ensuite chaque fois que le cylindre est enlevé et rattaché, examinez tous les raccordements pour déceler les fuites. Arrêtez les valves de gril et ouvrez la valve principale de cylindre, puis vérifiez les raccordements avec de l'eau savonneuse. Réparez toutes les fuites avant d'allumer le gril.

**ATTENTION:** Tournez toujours la valve principale de cylindre de propane au loin après chaque utilisation, et avant de déplacer le gril et le cylindre, ou débrancher l'accouplement. Cette valve doit rester fermée et le cylindre a débranché alors que l'appareil n'est pas en service, quoique l'écoulement de gaz soit arrêté par un dispositif de sûreté quand le coupleur est débranché.

**Inspectez soigneusement** l'ensemble de tuyau chaque fois avant que le gaz soit allumé. Un tuyau criqué ou frangé devrait être remplacé immédiatement.

Si l'appareil est stocké à l'intérieur, le cylindre doit être disconnected et a enlevé. Des cylindres Disconnected doivent être stockés dehors, hors de la portée des enfants, avec les prises de valve filettées étroitement installées, et ne doivent pas être stockés dans un bâtiment, le garage, ou n'importe quel autre secteur inclus.

### POUR VOTRE SÛRETÉ

- Ne stockez pas un cylindre de gaz disponible de propane dessous ou ne vous approchez pas de cet appareil.
- Ne remplissez jamais cylindre au delà de 80 pour cent de plein.
- SI L'INFORMATION DANS "A" ET "B" N'EST PAS SUIVIE EXACTEMENT, UN FEU CAUSANT LA MORT OU DES DOMMAGES SÉRIEUX PEUT SE PRODUIRE.

**Fig. 12-1 type coupleur rapide de fil de point culminant d'I**

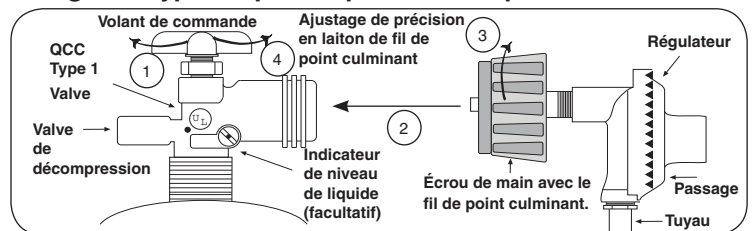

### CONDITIONS DE CLÔTURE

**POUR VOTRE SÛRETÉ,** vous devez fournir les ouvertures suivantes ci-dessous pour le drainage, l'air de recharge, et la ventilation en travers de n'importe quelle zone de stockage exposée à la fuite possible des raccordements de gaz, du gril, ou du cylindre de propane:

Un côté de la clôture de cylindre de gaz a laissé complètement ouvert de extérieur OU en fournissant quatre (4) ouvertures de ventilation. Deux ouvertures doivent être au niveau de valve de cylindre (approximativement 16" (40.6 centimètres) au-dessus du plancher) et sur les murs opposés de la clôture. Deux ouvertures supplémentaires doivent être au niveau de plancher des côtés opposés de la clôture. Les ouvertures de niveau de plancher doivent commencer au plancher et se prolongeront pas plus haut que 5" (12.7 centimètre) au-dessus du plancher. Chaque ouverture doit avoir un minimum de 10 pouces carrés (64.5 cm<sup>2</sup>) du secteur libre. Pour réaliser la ventilation appropriée, vous pouvez forer une série de trous, omettez le coulis des joints de maçonnerie, ou remplacez une brique avec un écran de tissu de matériel. Si le plancher dans le coffret est augmenté et l'espace sous le coffret est ouvert d'extérieur, les ouvertures inférieures de ventilation peuvent être dans le plancher.

### CARE AND CLEANING

APPLIANCE MUST BE COMPLETELY COOL WHEN CLEANING. DO NOT SPRAY ANY CLEANER OR LIQUIDS ON THE APPLIANCE WHEN HOT.

Stainless steel surfaces when exposed to temperatures produced by the grilling process will change color. The stainless steel will change color from silver to brown and blue. This can be removed by using Fire Magic Stainless Steel Cleaner (3581-1).

Clean your appliance by first using Fire Magic Barbecue and Grill Cleaner (part #3580-1) to remove grease and dirt. Always wipe with the grain (See Fig. 13-1). Next, use Fire Magic Stainless Steel Cleaner (3581-1) to restore the stainless steel color (Note: not for mirror finish). Finish by wiping your appliance down using Fire Magic Polish Wipes (3586-1). **To clean the mirror panel (if applicable), use a quality brand glass cleaner only, not any of the cleaners mentioned above.**

Clean your appliance at least once a month.

If your appliance is installed in a seaside (salt air) or poolside (chlorine) location, it will be more susceptible to corrosion and must be maintained/cleaned more frequently. Do not store chemicals (such as chlorine or fertilizer) near your stainless steel appliance.

Due to the nature of stainless steel, surface iron oxide deposits may appear. Do not be alarmed – these deposits are removable with stainless-steel cleaner through prompt and periodic maintenance. If not attended to promptly, permanent pitting may occur.

Check and clean the burner ports and burner carry-over slits for blockage at least annually by removing the burner (see orifice changing instructions) and visually inspecting the burner inlet for insects and nests. A clogged burner can lead to a fire in the bottom of the appliance. (For Fire Magic grills use Maintenance Kit part #MK-1.)

The inside of the appliance may be cleaned periodically with oven cleaner if desired. Follow the oven cleaner instructions for proper use.

Be careful not to get oven cleaner on the outside surface of the appliance as it can permanently damage the finish.

By following these recommendations, you will enjoy the beauty and convenience of your appliance for many years to come.



Fig. 13-1 - Wipe with grain

### PROTECTING YOUR APPLIANCE FROM THE WEATHER

An optional heavy-duty cover will protect your appliance's finish and protect your investment. The water repellent cover will protect your appliance from the weather. Always cover your appliance when not in use. (Allow to cool before covering.)

Please specify the model number and serial number of your appliance when ordering a cover.

### IMPORTANT

**IN THE EVENT OF A GREASE FIRE, IMMEDIATELY SHUT OFF THE MAIN GAS VALVE TO THE GRILL. KEEP THE LID OPEN AND ALLOW THE FIRE TO EXTINGUISH ITSELF. A THOROUGH INSPECTION BY A TRAINED SERVICE TECHNICIAN SHOULD BE CONDUCTED BEFORE FUTURE USE OF YOUR GRILL. THE SERVICE TECHNICIAN WILL CHECK THE SYSTEM FOR GAS LEAKS AND WILL CHECK ALL ELECTRICAL WIRING FOR DAMAGE. ALL GAS LEAKS AND WIRING MUST BE REPAIRED PRIOR TO FUTURE USE.**

## CHECKING AND CONVERTING GAS TYPE

This unit comes from the factory configured for one type of gas, as marked on the label behind the control panel.

**Converting this unit to burn a different type of gas requires a conversion kit from the factory. The professional installer who converts this unit to burn a different gas must perform the following functions:**

1. Change brass gas orifices (included at original shipping) on each burner to match the new gas type (see PRODUCT DATA TABLE, Table 1).
2. Switch the convertible gas regulator (included at original shipping, located behind the control panel) to match the new gas type (see below).
3. Plumb the unit to the new gas supply.
4. Apply a new label behind the control panel, indicating the new gas the unit will burn (included with conversion kit).

### **WARNING**

**HAZARDOUS OVERHEATING WILL OCCUR IF A NATURAL-GAS ORIFICE IS USED WITH PROPANE GAS. IF YOU ARE NOT SURE IF THE CORRECT ORIFICES ARE INSTALLED, OR IF AN ORIFICE CHANGE IS NECESSARY, REFER TO THE FOLLOWING INSTRUCTIONS.**

**CAUTION:** Make sure the unit is at a safe temperature and isolated from gas and electrical supplies before beginning the tasks outlined below.

**Note:** The cooler the unit, the greater the tolerances between the stainless-steel parts, and therefore the easier to disassemble and reassemble parts of the unit.

**CAUTION:** For your safety, exercise caution and use adequate hand protection (such as gloves) when handling potentially sharp sheet-metal parts.

## CHECKING AND CONVERTING THE REGULATOR

Regulator: note the cap on top

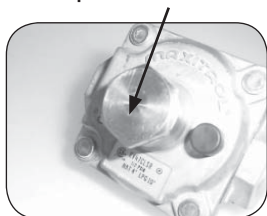

**Note:** Each end of the plastic converter is engraved with either the letters "NAT" or "L.P." (propane) for the respective gasses. When the converter is in the cap and the cap is held uppermost, the letters seen indicate the gas that the regulator is set up for.

To convert the regulator from one gas to another, follow steps 1-4.

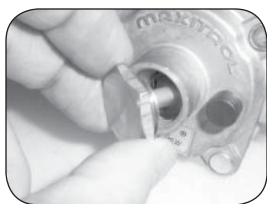

**STEP 1:** Unscrew and remove the cap from the regulator, extracting the converter.



Read gas type here

**STEP 3:** Turn the converter around and replace it carefully, into the center of the cap (it will snap into place). Check that you can read the type of gas the unit is set for.



**STEP 2:** Remove the converter (the plastic stalk) by carefully pulling it away from the center of the cap (it will snap out of its seating).

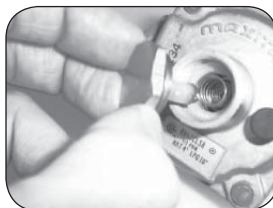

**STEP 4:** Replace the unit into the regulator and screw down until snug.

### **WARNING**

THIS APPLIANCE REGULATOR IS RATED FOR 1/2 PSI MAXIMUM. IF YOUR GAS SUPPLY IS GREATER THAN 1/2 PSI, AN ADDITIONAL REGULATOR MUST BE INSTALLED TO REDUCE THE INPUT PRESSURE TO THE UNIT TO 1/2 PSI OR LESS. SEE GAS-SUPPLY REQUIREMENTS SECTION FOR PROPER GAS-SUPPLY PRESSURE.

## REPLACING THE IGNITOR BATTERY

1. Remove the ignitor cover by turning it counterclockwise.



**Important:** Do not attempt to pull or turn the rubber cap.



2. Remove battery for replacement. The battery is reinstalled with the negative (-) end out.



3. After properly inserting the battery, replace the ignitor cover by turning the cap clockwise.



**Note:** If you have accidentally removed the rubber cap, follow the instructions below to replace it.

1. Pull the rubber cap and the inner plastic sleeve apart.  
 2. Carefully insert the rubber cap into over and slide the ignitor cover so inner plastic sleeve it sits behind inner into the cap.  
 3. Turn the cap lip.



## TROUBLESHOOTING

If you have trouble with the unit, please use this list to identify the problem. By trying one or more of the solutions to the possible cause, you should be able to solve the problem. If this list does not cover your present problem, or if you have other technical difficulties with the unit, please contact your local dealer.

PROBLEM	POSSIBLE CAUSE	CORRECTION
<b>Ignition system failure</b>	1) Improper air shutter adjustment	1) Adjust air shutters.
	2) Ignition wire disconnected	2) Replug wires into generator.
	3) Low gas pressure	3) Adjust or replace battery.
	4) Dead battery	4) Replace battery.
<b>Insufficient heat</b>	1) Improper air shutter adjustment	1) Adjust air shutters.
	2) Using propane orifice for natural gas	2) Change orifices.
	3) Low gas pressure/flame (natural)	3) Have gas company check the operating pressure at the unit.
	4) Low gas pressure/flame (propane)	4) Refill propane tank, or reset propane tank safety*: Shut off all valves (including propane tank) and follow lighting instructions exactly.
<b>Uneven heating</b>	1) Burner ports partially blocked by debris	1) Remove burners and clean out ports.
	2) Small spiders or insects in burner	2) Inspect burners for spider webs or other debris that may block gas flow.
<b>Burner goes out on LOW</b>	1) Valve "Low" setting needs adjustment	1) Light burner on HIGH, immediately turn to LOW setting. Remove knob from valve and using a small flat screwdriver, slowly turn the adjustment screw in the stem, a little at a time (30° to 45°), in either direction, until the flame is approximately 1/4" in height from burner ports.

**Note:** \*Propane tanks are equipped with a safety shutdown device that may cause low or no gas/flame at the burners if operating and lighting instructions are not followed exactly. If you suspect the propane tank safety shutoff is in effect, shut off all burner control valves and the propane tank valve. Then read and follow the LIGHTING INSTRUCTIONS exactly. Lighting instructions are located in the owner's manual. If the problem persists, continue troubleshooting, or contact your local dealer or distributor for assistance.

# AMERICAN OUTDOOR GRILL LIMITED WARRANTY

## AMERICAN OUTDOOR GRILL LIMITED WARRANTY

**American Outdoor Grill stainless steel burners are warranted for 15 YEARS**  
**All other American Outdoor Grill parts are warranted for 10 YEARS**

Except as noted below

American Outdoor Grill ignition systems (excluding batteries), accessories (including sideburners, motors, and thermometers), and flavor grids are warranted for one year from the date of purchase.

### PLEASE KEEP A COPY OF YOUR SALES SLIP FOR PROOF OF PURCHASE

This warranty applies to the original purchaser and to single family residential use only. It commences from date of purchase, and is valid only with proof of purchase.

This warranty does not cover parts becoming defective through misuse, accidental damage, electrical damage, improper handling, storage, and/or installation. Product must be installed (and gas must be connected) as specified in the instructions or operator's manual, by a **qualified professional installer**. Accessories, parts, valves, remotes, etc., when used must be Peterson Co. product.

This warranty **does not** apply to rust, corrosion, oxidation, or discoloration, unless the affected component becomes inoperable. It **does not** cover labor or labor-related charges.

This warranty specifically excludes liability for **indirect, incidental**, or consequential damages. Some states do not allow the exclusion or limitation of incidental or consequential damages, so the above exclusion may not apply to you. This warranty gives you specified legal rights, and you may have other rights that may vary from state to state.

For additional information regarding this warranty, or to place a warranty claim, contact the R.H. Peterson dealer where the product was purchased.

**TO REGISTER YOUR PRODUCT ONLINE GO TO: [WWW.AMERICANOUTDOORGRILL.COM](http://WWW.AMERICANOUTDOORGRILL.COM),  
AND CLICK ON PRODUCT REGISTRATION. THANK YOU FOR YOUR PURCHASE.**

American Outdoor Grills  
14724 Proctor Ave.  
City of Industry, CA 91746

Quality Check			Date: _____		
Burner Orifices	Nat.	L.P.	Leak Test: _____	Model#: _____	
Main:	_____	_____	Burn Test: _____	Serial#: _____	
Other:	_____	_____	Gas Type: <u>Nat. / L.P.</u>	Air Shutter: _____	
				Inspector: _____	