

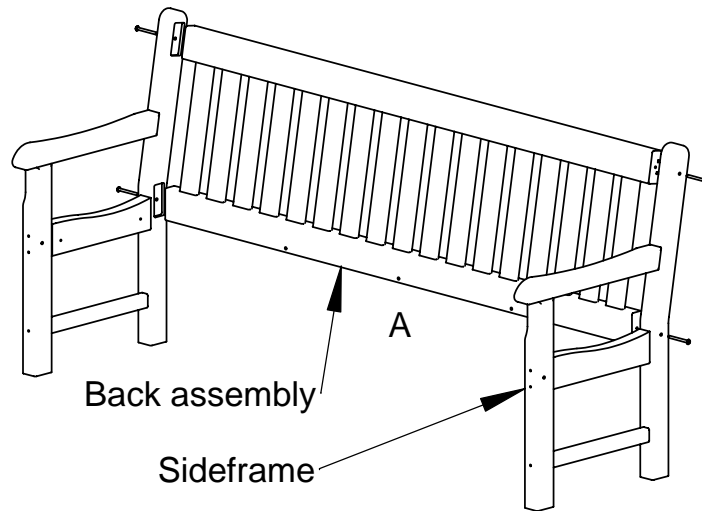

Assembly Instructions
Model: RKB72

- (1) Hardware pack
- (2) Sideframes
- (1) Back assembly
- (1) Seat assembly

Step 1
Attach sideframes to back assembly
using (4) 3" chair screws in pre-drilled holes



Step 2
Attach front of seat assembly to sideframes
using (2) 3" chair screws in pre-drilled holes

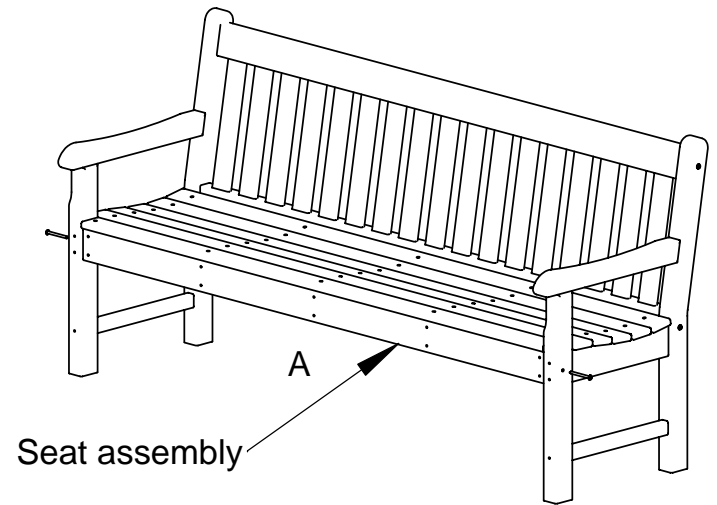

Step 3
Secure the bottom of the Back assembly
to the back of the Seat assembly
using (3) 3" chair screws in pre-drilled holes

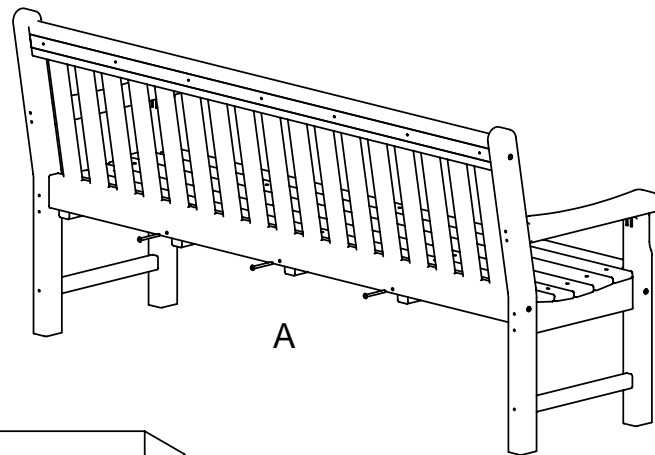

Step 4
Attach seat assembly to sideframes
using (4) 14x2½" screws in pre-drilled holes

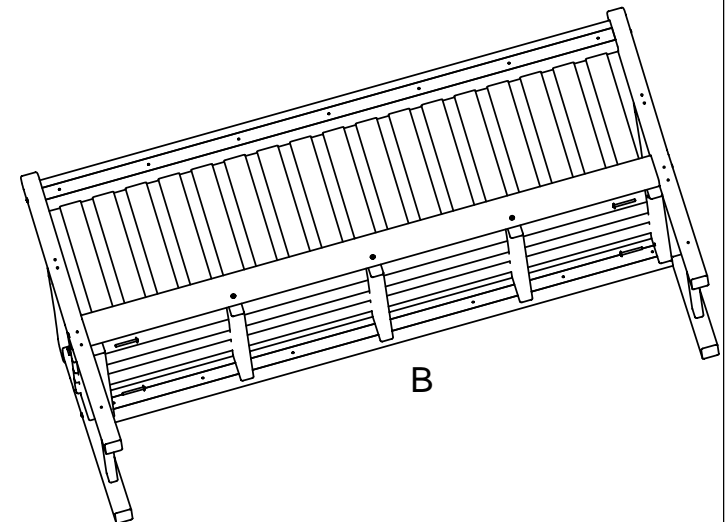

TOOLS NEEDED

Phillips head screwdriver
4mm HEX KEY: INCLUDED

Qty.	Description
9	A - 3" Chair screw
4	B - 14x2½" screw SS



Cleaning/Maintenance

Poly-Wood furniture is made of HDPE plastic resin that has been purified and UV protected. It is generally cared for and cleaned with soap and warm water. For certain stains and additional cleaning power, a 1/3 bleach and 2/3 water solution can be used without affecting the color. Also, a popular method of cleaning is a high-pressure power wash. (Not to exceed 1,500 psi.) The surface characteristics of the product may require the use of a soft bristle brush to get into the creases.

The hardware used in the assembly and construction of our furniture is a 300 series commercial grade stainless steel that has an additional "Xylan" protective and cosmetic coating. Although the quality of the hardware has a high level of corrosive resistance, the hardware can show some sign of corrosion, especially in salt air environments. A practical solution to these signs of corrosion would be to wash the product with soap and warm water. Use a soft bristle brush to scrub the corroding areas of the hardware. Also, appliance touch up paint may be used in the appropriate color to protect the hardware. Appliance touch up paint can be purchased at local hardware stores.

Warranty

Poly-Wood, Inc. warranties to the original purchaser for a period of five (5) years of residential use and one (1) year for commercial use starting from the date of purchase. This warranty covers any defects in the manufacturing and workmanship of the furniture components. "Defects" is defined as imperfections that impair the original function of the product. This warranty does not apply to normal wear and tear effects on the furniture, which are received by regular use of the furniture. Neither does it cover damage due to unauthorized repairs or alterations, negligence, misuse or abuse, improper assembly and acts of God. This warranty does not apply to the hardware used to assemble the furniture.

The original purchaser is responsible for providing sales support with the proper documentation needed to determine a resourceful solution for the defect. Possible solutions are replacement or repair of the defective furniture, replacement or repair of defective component, or authorization repairs by a third party.

The proper documentation required is by providing the proof of purchase with the original receipt and a written explanation of how the defect occurred. Once the documentation has been received and evaluated, the customer will be notified of the solution. If the product is not returned within 60 days of date of purchase, the customer is responsible for all shipping charges that may apply.

Poly-Wood Cushion Warranty: Poly-Wood, Inc. warranties to the original purchaser for a period of one (1) year from date of purchase. This warranty does not apply to normal wear and tear effects on the cushions, which are received by regular use of the cushions. Neither does it cover damage due to unauthorized repairs or alterations, negligence, misuse or abuse, improper assembly and acts of God. This warranty covers any defects in the manufacturing and workmanship of the cushion.

Send the proper documentation to your retailer.

Sit back, relax and forget about it.